



Operating Instructions

LVC-C300
LVC-C310

Before installing and using the camera, please read these instructions thoroughly and retain them for later reference.

	CAUTION RISK OF ELECTRIC SHOCK DO NOT OPEN	
<p>CAUTION: TO REDUCE THE RISK OF ELECTRIC SHOCK, DO NOT REMOVE COVER (OR BACK) NO USER SERVICEABLE PARTS INSIDE. REFER SERVICING TO QUALIFIED SERVICE PERSONNEL.</p>		



This symbol is intended to alert the user to the presence of uninsulated "dangerous voltage" within the product's enclosure that may be of sufficient magnitude to constitute a risk of electric shock to persons.



This symbol is intended to alert the user to the presence of important operating and maintenance (servicing) instructions in the literature accompanying the appliance.

Warning

To prevent fire or shock hazard, do not expose the unit to rain or moisture. To avoid electrical shock, do not open the cabinet. Refer servicing to qualified personnel only.

Regulatory Notices For U.S.A

This equipment has been tested and found to comply with the limits for a Class A digital device, pursuant to Part 15 of the FCC Rules. These limits are designed to provide reasonable protection against harmful interference when the equipment is operated in a commercial environment. This equipment generates, uses, and can radiate radio frequency energy and, if not installed and used in accordance with the instruction manual, may cause harmful interference to radio communications. Operation of this equipment in a residential area is likely to cause harmful interference in which case the user will be required to correct the interference at his own expense.

- A suitable conduit entries, knock-outs or glands shall be provided in the cable entries of this product in the end user.
- Caution: Danger of explosion if battery is incorrectly replaced. Replaced only with the same or equivalent type recommended by the manufacturer. Dispose of used batteries according to the manufacturer's instructions.
- Holes in metal, through which insulated wires pass, shall have smooth well rounded surfaces or shall be provided with brushings.

Warning

This is a class A product. In a domestic environment this product may cause radio interference in which case the user may be required to take adequate measures.

Contents

Features	3
Cautions for Safe Operation	4
Operating Controls and Their Functions	5
Power IN/CONTROL	6
External Key(A/D IN)	7
MENU DESCRIPTIONS	8
CAMERA ID	9
FOCUS MODE SET	10-11
AWB SET	12-13
AE SET	14-16
SPECIAL SET	17-18
MOTION DET	19
F. OSD SET	20
E. SENSITIVITY	21
WDR SET	22
On-Screen Display	23-24
Specifications	25-26

FEATURES

The power zoom color video camera is designed for use in monitoring system.

- High resolution and high sensitivity with a 1/4 inch CCD (Charge Coupled Device)
- High magnitude of zoom lens with optical X 27, Digital X 270(MAX)
- Auto Focus
- Auto White balance
- Auto exposure with DC Iris control
- Day & Night function : LVC-C310
- DSS(Digital Slow Shutter) is available : Optional
- WDR(Wide Dynamic Range) is available : Optional

Cautions for Safe Operation

Power Supply

This camera must always be operated a 12V DC power supply.

Handling of the unit

Be careful not to spill water or other liquids on the unit, or to get combustible or metallic material inside the body. If used with foreign matter inside, the camera is liable to fail, or to be a cause of fire or electric shock.

Operating and storage location

Avoid viewing a very bright object (such as light fittings) for an extended period. Avoid operating or storing the unit in the following locations.

- Extremely hot or cold places (operating temperature 0°C-45°C)
- Damp or dust place
- Where it is exposed to rain
- Where it is subject to strong vibration

- Close to generators of powerful electromagnetic radiation such as radio or TV transmitters.

Care of the unit

- Remove dust or dirt on the surface of the lens with a blower.
- Use a dry soft cloth to clean the body. If it is very dirty, use a cloth dampened with a small quantity of neutral detergent, then wipe dry.
- Avoid the use of volatile solvents such as thinners, alcohol, benzene, and insecticides. They may damage the surface finish and/or impair the operation of the camera.

Operating Controls and Their Functions

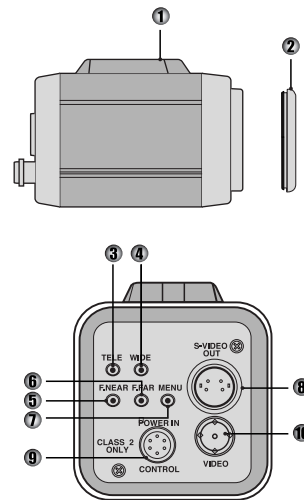

1. Tripod adaptor

This adaptor can also be attached on the bottom of the camera.

2. Lens mount cap

3. TELE Key

When push the TELE KEY, picture is telephoto

4. WIDE Key

When push the WIDE KEY, picture is wide angle

5. Focus Near Key

In a manual situation, focus get near.

6. Focus Far Key

In a manual situation, focus get far.

7. Menu Key

If you want to set up a diverse function, you can push this button.

8. Video output (S-Video type)

Connect to the S-Video in connector of a monitor.

9. Interface of camera control JACK (6 Pin Din Jack Type)

- Connect to an external voltage controller
- You can supply a camera with power from this. (DC12V)

10. Video output(BNC type)

Connect to the video in connector of a monitor.

Power In / Control

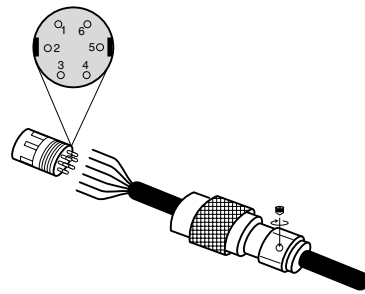

You can adjust focus and zoom by a pin terminal on the back side of the camera.

JK301			* Wire Color	
1	ZOOM	} Zoom & Focus DC Control	1	Green
2	FOCUS		2	White
3	AD1	→ A/D KEY 1 input	3	Brown(Blue)
4	COMMON	→ Common 502 Zoom & Focus	4	Yellow
5	GND	→ Common GND	5	Black
6	12V	← Power Supply Input 9V~15V	6	Red

* is the color of the cable.(If it is offered)
Adjust voltage from 1 pin and 2 pin

PIN NO.	1	2
RATE	±6V	±6V
LIMIT	+	3V ~ 13V
	-	-3V ~ -13V

External Key (A/D IN)

Schematic diagram of wired remote-control

1) C300'S

NO	Function
AD1(1)	Power ON/OFF
AD1(2)	Menu ON/OFF
AD1(3)	Tele or Menu up
AD1(4)	Wide or Menu down
AD1(5)	Nega / Posi
AD1(6)	Focus Near or Menu change
AD1(7)	Focus Far or Menu change
AD1(8)	A/M or Push Auto

2) C310'S

NO	Function
AD1(1)	Day & Night ON/OFF
AD1(2)	Menu ON/OFF
AD1(3)	Tele or Menu up
AD1(4)	Wide or Menu down
AD1(5)	Nega / Posi
AD1(6)	Focus Near or Menu change
AD1(7)	Focus Far or Menu change
AD1(8)	A/M or Push Auto

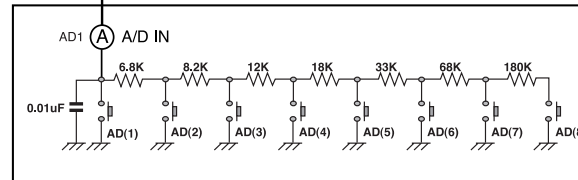
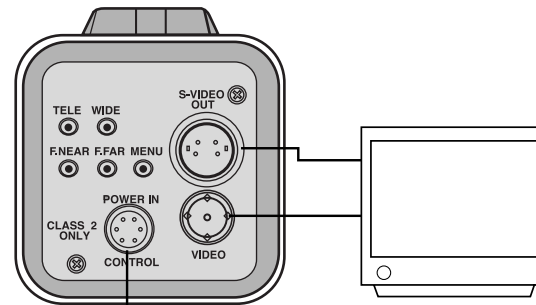

MENU DESCRIPTIONS

MENU		
CAMERA ID	OFF	page 9
FOCUS SET	↕	page 10
AWB SET	↕	page 12
AE SET	↕	page 14
SPECIAL SET	↕	page 17
MOTION DET	↕	page 19
F OSD DISP	↕	page 20
E SENSITIVE	↕	page 21
WDR SET	↕	page 22
EXIT	↕	

Using TELE, WIDE, FOCUS+, FOCUS- button

- **TELE** and **WIDE** are used for **UP** and **DOWN**.
- **FOCUS+** and **FOCUS-** are used for **INCREASE** and **DECREASE** the data.

CAMERA ID

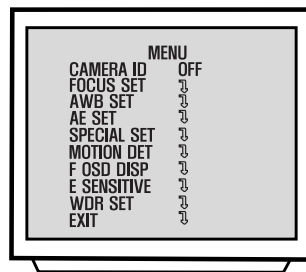

1. CAMERA ID

To connect a large number of camera , It can be assigned to identification number to each camera for camera control easily.

(OFF, 0 - 255 : total numbers of ID are 256)

- It only can be set this function using ID commend.

To transfer ID Code of camera , In first byte at PC control.
Set the ID number of camera , and then the ID number display continuously.

FOCUS MODE SET

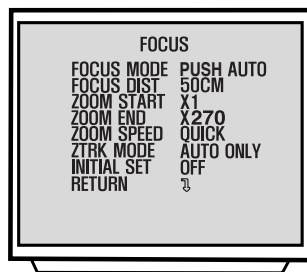

2. Focus Set:

2-1. Focus Mode Set :

This function is for focus mode setting

- A) Set up "FOCUS SET" in main menu using Menu key.
Select the "FOCUS MODE" in submenu using Tele/Wide key. And then set the mode (Auto, Push auto, or Manual) using Focus key.

2-2. Focus Distance Set :

This function is for selection of minimum shooting distance.

- A) Select the "FOCUS DIST" in submenu using Tele/wide key.
B) Set the focus distance mode from 1cm to 5M. (1cm, 10cm, 50cm, 1M, 3M, 5M) using Focus key.

2-3. ZOOM START Set :

This function is for selection of zoom start position.

- A) Select the "ZOOM START" in submenu using Tele/wide key.
B) Set the Zoom start mode from x1 to x27. using Focus key.

FOCUS MODE SET

FOCUS	
FOCUS MODE	PUSH AUTO
FOCUS DIST	50CM
ZOOM START	X1
ZOOM END	X270
ZOOM SPEED	QUICK
ZTRK MODE	AUTO ONLY
INITIAL SET	OFF
RETURN	↵

2-4. ZOOM END Set :

This function is for selection of zoom end position.

- A) Select the "ZOOM END" in submenu using Tele/wide key.
- B) Set the Zoom end mode from (Zoom Start + 1) x 270 to X using Focus key.

2-5. ZOOM SPEED Set :

This function is for selection of zoom speed.

- A) Select the "ZOOM SPEED" in submenu using Tele/wide key.
- B) Set the Zoom speed, Slow, Middle , Quick using Focus key.

2-6. ZOOM TRACKING MODE Set :

This function is for selection of zoom tracking mode.

- A) Select the "ZTRK" in submenu using Tele/wide Command,
- B) Set the Zoom tracking mode to Auto or Manual.

* Zoom tracking means focused zooming state.

2-7. INITIAL SET :

If initial mode set to ON, All FOCUS SET function is changed to the factory setting.

- A) Select the "INITIAL SET" in submenu using Tele/wide key.
- B) Set the initial set mode to ON or OFF using Focus key.

2-8. RETURN TO MAIN MENU :

This function is exit to main menu.

- A) Select the "RETURN" in submenu using Tele/wide key.
- B) Set the return mode using Focus key.

AWB SET

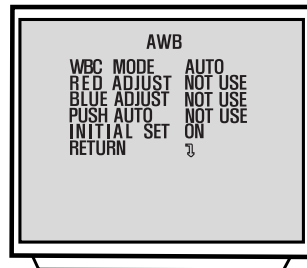

3. AWB SET

3-1. WB Mode Set :

This function is for changing the WB mode.

- A) Set up "AWB SET" in main menu using Tele/wide key.
- B) Select the "WB MODE" in submenu using Tele/wide key.
- C) Set the mode Auto, Push auto , Manual, Outdoor, Indoor, Special using Focus key.

***WBC MODE ; Use for changing White Balance Mode .**

- 1) AUTO ; WB Range 2800 °K ~ 8000 °K .
- 2) PUSH AUTO ; Set the AWB mode to Push Auto, then WB Mode is auto.
- 3) SPECIAL ; Under the special WB condition(Differ from curve of the control color temperature) , Adjust Red and Blue to perform a desired Auto White Balance.

3-2. RED ADJUST Set :

This function is available for Special ,Push Auto, Manual WB mode.

This mode is the adjustment of user option for special color.

- A) Select the "RED ADJUST" in submenu using Tele/wide key.
- B) Adjust the level from (-30 to 30 SPECIAL, -128 to +127 PUSH AUTO, 0-255 MANUAL) using Focus key.

AWB SET

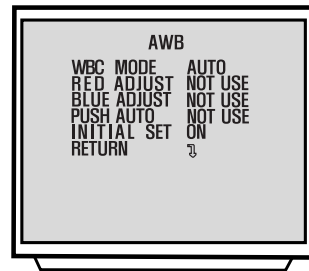

3-3. BLUE ADJUST Set :

This function is available for Special ,Push Auto, Manual WB mode.

This mode is the adjustment of user option for special color.

- A) Select the "BLUE ADJUST" in submenu using Tele/wide key.
- B) Adjust the level from (-30 to 30 SPECIAL, -128 to +127 PUSH AUTO, 0-255 MANUAL) using Focus key.

3-4. PUSH AUTO :

In case of PUSH AUTO WB mode.

Adjust the push auto mode ON, WB act automatically.

3-5. INITIAL SET :

If initial mode set to ON, All AWB function is changed to the factory setting

- A) Select the "INITIAL SET" in submenu using Tele/wide key.
- B) Set the initial set mode to ON or OFF using Focus key.

3-6. RETURN TO MAIN MENU :

This function is exit to main menu.

- A) Select the "RETURN " in submenu. Using Tele/wide key.
- B) Set the return mode using Focus key.

AE SET

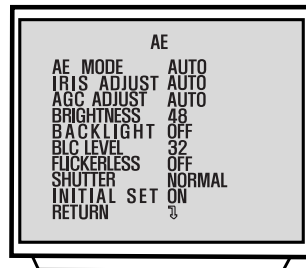

4. AE SET

4-1. AE Mode Set :

This function is for changing to AE mode.

- A) Set up "AE SET" in main menu using Tele/wide key.
- B) Select the "AE MODE" in submenu using Tele/wide key.
- C) Set the mode auto, IRIS MAN, AGC MAN, Manual, Auto using Focus key.

4-2. IRIS ADJUST Set :

This function is available for IRIS MAN mode.

- A) Select the "IRIS ADJUST" in submenu using Tele/wide key.
- B) Adjust the level from ##MIN to ##MAX(MANUAL, IRIS MAN) using Focus key.

* ## : Current level at Auto mode.

4-3. AGC ADJUST Set :

This function is available for AGC MAN mode.

- A) Select the "IRIS ADJUST" in submenu using Tele/wide key.
- B) Adjust the level from ##MIN to ##MAX(MANUAL, AGC MAN) using Focus key.

* ## : Current level at Auto mode.

AE SET

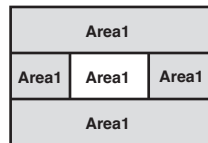
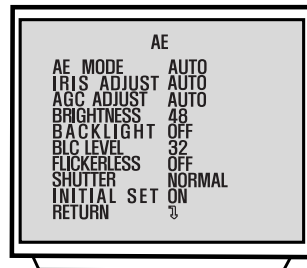

Auto BLC

4-4. BRIGHTNESS ADJUSTMENT Set :

- Select the "BRIGHTNESS" in submenu using Tele/wide key.
- Adjust the level from ##MIN to ##MAX. using Focus key.

* ## : Current level at Auto mode.

4-5. BACKLIGHT Set :

- Select the "BACKLIGHT" in submenu using Tele/wide key.
- Set the mode OFF, ON, or AUTO using Focus key.

* Auto BLC (Auto back light compensation)

When a back light condition occurs in area1,area2, area3, or area4. the back light compensation is enable. When the back light condition disappears in that area,

BLC is disable automatically. If do not want this mode, set to OFF

4-6. FLICKERLESS Set :

- Select the "FLICKERLESS" in submenu using Tele/wide key.
- Set the mode OFF, ON using Focus key.

* FLICKERLESS ; Use for removing the flicker of picture

ON : Remove the flicker (In case of PAL System ; Shutter Speed 1/120 sec).

AE SET

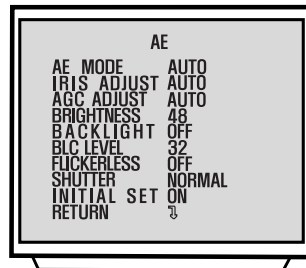

4-7. SHUTTER SPEED Set :

- A) Select the "SHUTTER" in submenu using Tele/wide key.
- B) Set the mode NORMAL, 1/125 - 1/10000 using Focus key.

4-8. INITIAL SET :

- A) Select the "INITIAL SET" in submenu using Tele/wide Command,

- B) Set the initial set mode to ON or OFF using Focus key.

4-9. RETURN TO MAIN MENU :

This function is exit to main menu.

- A) Select the "RETURN " in submenu using Tele/wide key.
- B) Set the return mode using Focus key.

SPECIAL SET

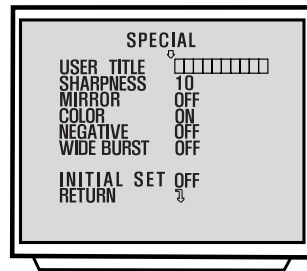

5. SPECIAL SET

5-1. User Title Set :

This function is for custom title on screen display.

- A) Set "SPECIAL SET" in main menu using Tele/wide key.
- B) Select the "USER TITLE" in submenu using Tele/wide key.
- C) Set the position of title and set data using Tele / Wide, Focus key.

5-2. SHARPNESS ADJUST Set :

- A) Select the "SHARPNESS" in submenu using Tele/wide key.
- B) Adjust the level from 0 to 15 using Focus key.

5-3. MIRROR Set :

- A) Select the "MIRROR" in submenu using Tele/wide key.
- B) Select the mode ON, OFF using Focus key.

5-4. COLOR Set :

This mode is for B/W mode.

- A) Select the "COLOR" in submenu using Tele/wide key.
- B) Select the mode ON, OFF using Focus key.

SPECIAL SET

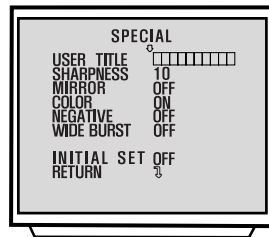

5-5. NEGATIVE Set :

This mode is to change color and luminance to negative.

- A) Select the "COLOR" in submenu using Tele/wide key.
- B) Select the mode ON, OFF using Focus key.

5-6. WIDE BURST Set :

This mode is to change color burst width for long distance application.

- A) Select the "WIDEBURST" in submenu using Tele/wide key.
- B) Select the mode ON, OFF using Focus key.

5-7. LANGUAGE SET :

- A) ENG / CHI : English / Chinese language select
- B) BLANK : English Only

5-8. INITIAL SET :

If initial mode set to ON, All SPECIAL functions are changed to the factory setting

- A) Select the "INITIAL SET" in submenu using Tele/wide key.
- B) Set the initial set mode to ON or OFF Using Focus key.

5-9. RETURN TO MAIN MENU :

This function is exit to main menu.

- A) Select the "RETURN" in submenu using Tele/wide key.
- B) Set the return mode Using Focus key.

MOTION DET

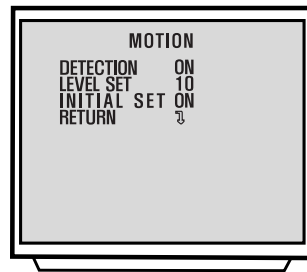

6. MOTION DETECTION SET

6-1. DETECTION Mode Set :

- A) Set "MOTION" in main menu using Tele/wide key.
- B) Select the "DETECTION" in submenu. Using Tele/wide key.
- C) Set the mode ON, OFF using Focus key.

6-2. LEVEL ADJUST Set :

This function is available for DETECTION ON mode.

- A) Select the "LEVEL SET" in submenu. Using Tele/wide key.
- B) Adjust the level to some sensitivity using Focus key.

6-3. INITIAL SET :

If initial mode set to ON, All MOTION functions are changed to the factory setting

- A) Select the "INITIAL SET" in submenu using Tele/wide key.
- B) Set the initial set mode to ON or OFF Using Focus key.

6-4. RETURN TO MAIN MENU :

This function is exit to main menu.

- A) Select the "RETURN" in submenu using Tele/wide key.
- B) Set the return mode Using Focus key.

F. OSD SET

7. F. OSD SET

7-1. FUNCTION Set :

- A) Set "F. OSD" in main menu using Tele/wide key.
- B) Select the mode what you want in submenu using Tele/wide key.
- C) Set the display mode of OSD using Tele / Wide, Near/Far key.

***INITIAL SET and RETURN are the same as before procedure.**

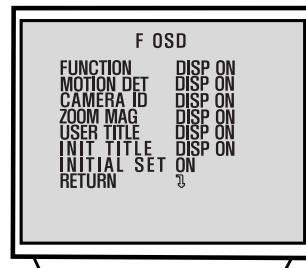

E. SENSITIVITY SET



8. E. SENSITIVITY SET: (OPTION)

8-1. E. SENSITIVITY SET

- A) Select the "E.SENSITIVITY" in submenu using Tele/wide key.
- B) Select the sensitivity mode what you want in submenu using Focus key.

*** Mode sequence : OFF-X2 AUTO-X4 AUTO-X8 AUTO-X10AUTO-X16 AUTO- X32 AUTO
-OFF- X2 FIX-X4 FIX -X8 FIX -X10 FIX -X16 FIX - X32 FIX-OFF**

8-2. INITIAL SET :

If initial mode set to ON, E.SENSITIVITY functions are changed to the factory setting

- A) Select the "INITIAL SET" in submenu using Tele/wide key.
- B) Set the initial set mode to ON or OFF Using Focus key.

8-3. RETURN TO MAIN MENU :

This function is exit to main menu.

- A) Select the "RETURN" in submenu using Tele/wide key.
- B) Set the return mode Using Focus key.

WDR SET

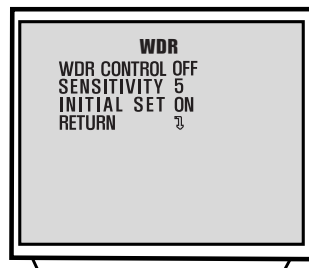

9. WDR SET (OPTION)

9-1. WDR SET

- A) Select the "WDR" in main menu using Tele/wide key.
- B) Select the "WDR CONTROL" in submenu using Tele/wide key.
- C) Select the WDR mode what you want in submenu using Focus key.

* **Mode sequence : OFF -- ON -- AUTO**

* **WDR Auto mode is working at the condition of high light back light.**

9-2. LEVEL ADJUST Set :

This function is the gain adjustment of WDR

- A) Select the "SENSITIVITY" in submenu using Tele/wide key.
- B) Adjust the level to some sensitivity using Focus key.

9-3. INITIAL SET :

If initial mode set to ON, All WDR functions are changed to the factory setting

- A) Select the "INITIAL SET" in submenu using Tele/wide key.
- B) Set the initial set mode to ON or OFF Using Focus key.

9-4. RETURN TO MAIN MENU :

This function is exit to main menu.

- A) Select the "RETURN" in submenu using Tele/wide key.
- B) Set the return mode Using Focus key.

On Screen Display

Some of these functions will be displayed every time the camera is operated and then disappeared after 5 seconds.

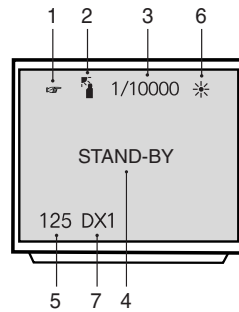

FUNCTION	OSD Format	Description
1. Focus Mode	Non display	Auto Mode
		Manual / push Auto Mode
2. Back Light	Non display	Back Light OFF
	"BL" display	BLC ON / Auto BLC Mode
3. Shutter Speed	Non display	Normal Shutter (PAL: 1/50)
	"Ff" display	Flickerless Mode
	1/125 ⋮ 1/10,000	28 variable steps.
4. STAND-BY	Indicate the camera stand-by during the camera's power turning ON.	
5. CAMERA ID	According to write the identification number to each camera, Multi-point control is available (PC Control 000~255).	

On Screen Display

FUNCTION	OSD Format	Description
6. WBC Mode		White Balance AUTO
	S_W	Special Auto White Balance; Adjustment Mode according to change of external illuminant. RED ADJUST and BLUE ADJUST (0~255) are available. After changing R/B value, The maintenance mode is "AUTO".
	☼	WB Preset for INDOOR (3200°K)
	☼	Wb Preset for OUTDOOR (5100°K)
	M_W	Manual WB Adjustment; In manual mode the HUE control is available (0 ~ 99).
	P_W	Push Auto White Balance; Turn this mode ON, the white trace automatically. Turn this mode OFF, preserve the white of final auto tracing action (Manual).
7. ZOOM Display	DX 270	Digital Zoom mode
	X 27	Optical Zoom mode

Specifications

Image device	1/4" interline transfer CCD
	NTST, High resolution : 811(H) X 508(V) 410K
	NTST, Normal resolution : 537(H) X 505(V) 270K
	PAL, High resolution : 795 (H) X 596 (V) 470K
	PAL, Normal resolution : 537(H) X 597(V) 320K
Sync system	Internal sync
Horizontal resolution	Approx.480 Line (NTSC, High resolution) 320 Line (NTSC, Normal resolution) 470 Line (PAL, High resolution) 320 Line (PAL, Normal resolution) (at center of screen)
Lens	X 27 Zoom (F 1.5 (W), F 3.8 (T) f= 3.25 ~ 88.0 mm), Video AF
Digital Zoom Ratio	X 10 (Total Zoom Ratio X 270)
Minimum illumination	Normal Mode : 1 Lux (30 IRE) Electronic Shutter Speed Mode : 0.01 Lux (X32 Field Accumulate) Night Mode : 0 Lux (Infrared ON)
S/N	More than 48dB
Scanning System	2:1 Interlace
Scanning Frequency(H)	15.734 kHz (NTSC), 15.625 kHz (PAL)
Scanning Frequency(V)	60Hz (NTSC), 50Hz (PAL)

Specifications

Focal Length	3.24mm (WIDE), 86mm (TELE)
OSD(On Screen Display)	English / Chinese
Power requirement	DC 9V-15V
Video output	Composite Output 75Ω Terminated / Y,C Separated
Power consumption	5.3W
operating temperature	0°C - 45°C
Operating Humidity	0% RH - 60% RH
Storage temperature	-20°C - 60°C, 0% RH - 85% RH
Dimensions	57mm(W) X 62.4mm(H) X 98.5mm(D)
Weight	500g

Specifications are subject to change without notice.

— |

| —

— |

| —



P/NO: 3834RC00???

